

Hearing aids – how much do they really help?

Harvey Dillon

Director, National Acoustic Laboratories

Parliamentary Breakfast
Hearing Awareness Week, 2012

Economic impact

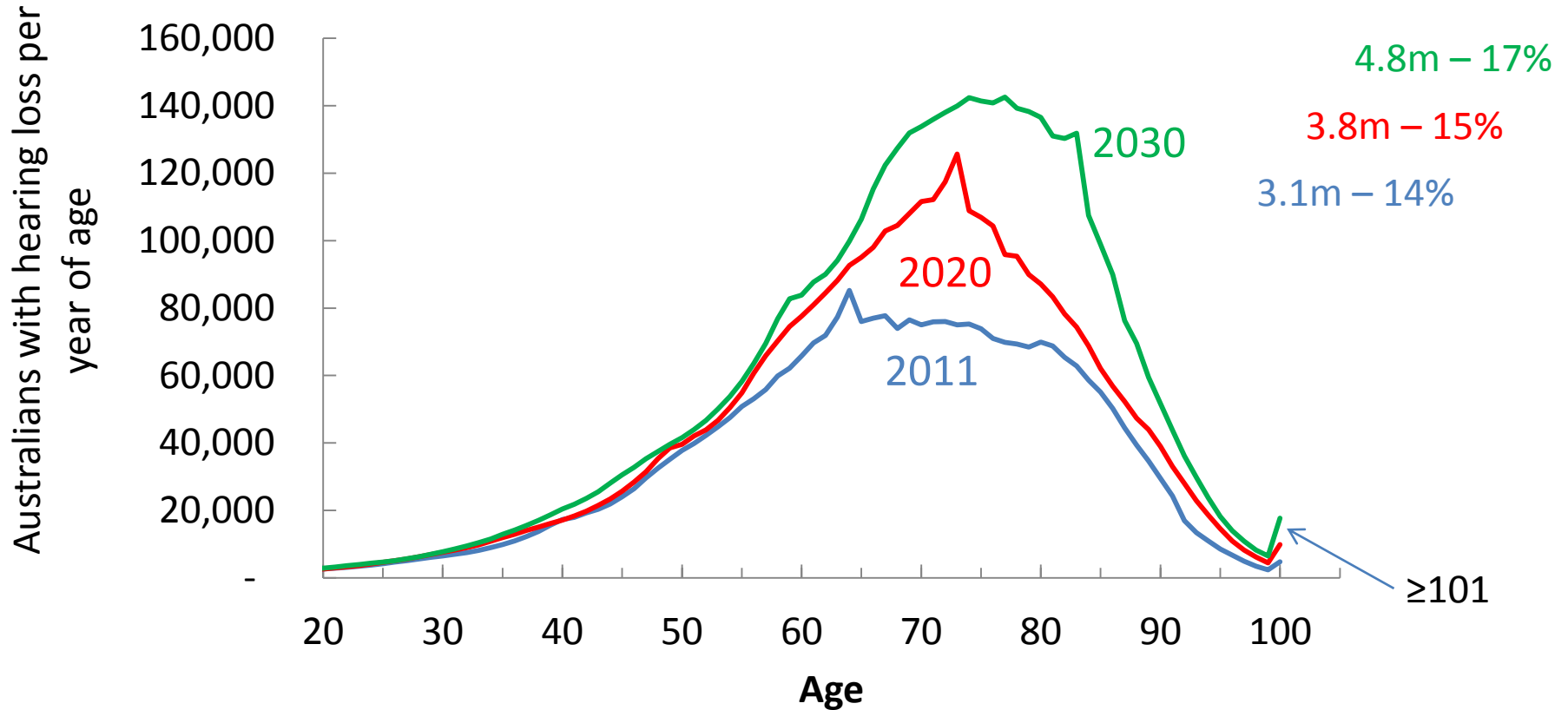

Untreated hearing loss leads to \$11.75 bn p.a. in lost economic activity – *Access Economics – Listen Hear! (2006)*

\$6.7 bn from productivity loss (lower work-force participation and effectiveness)

Use of hearing aids by new clients in Hearing Services Program

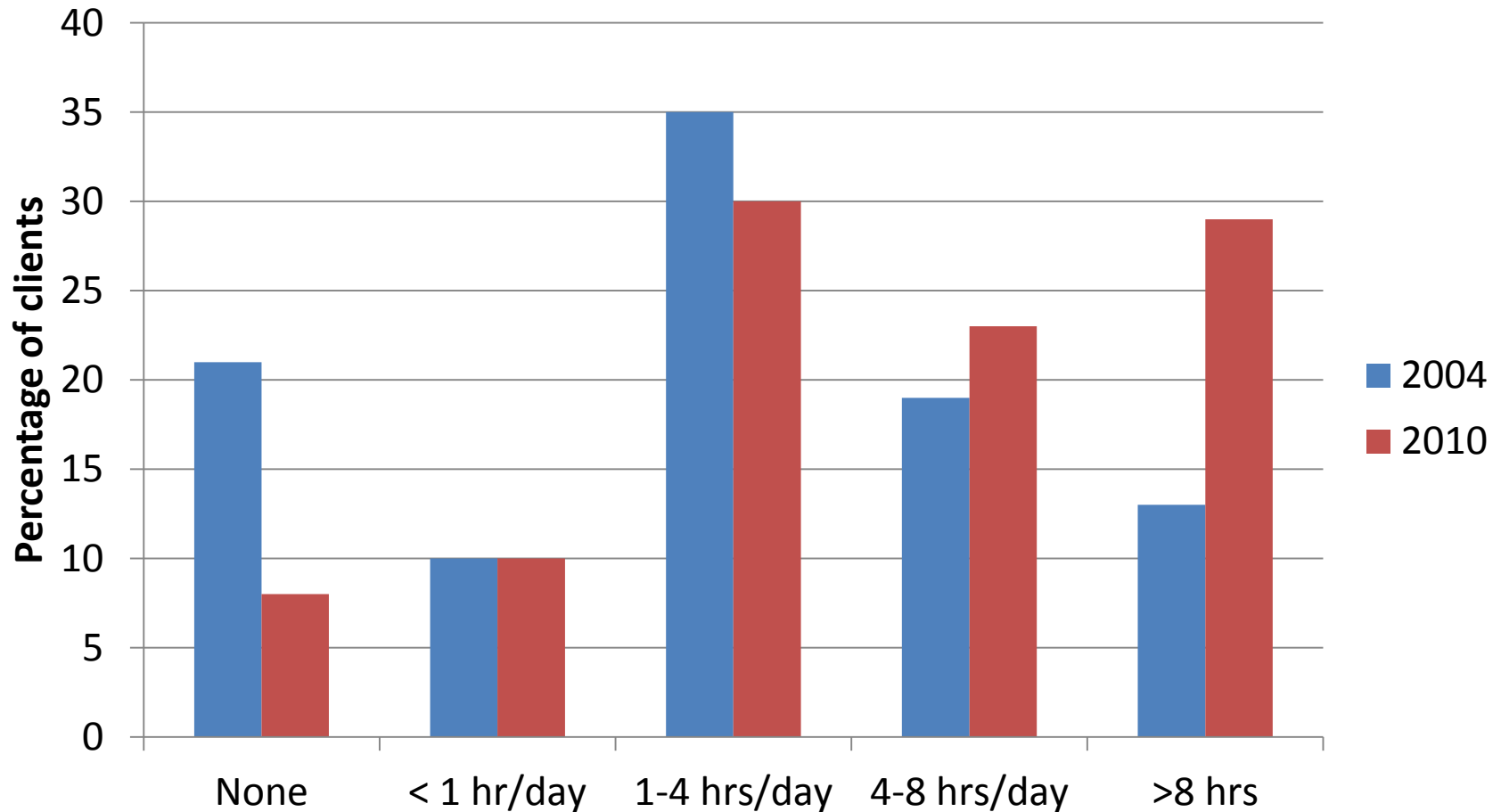

Impact of need

Current effect: $F(4, 490)=85.502, p=0.0000$

Vertical bars denote 0.95 confidence intervals

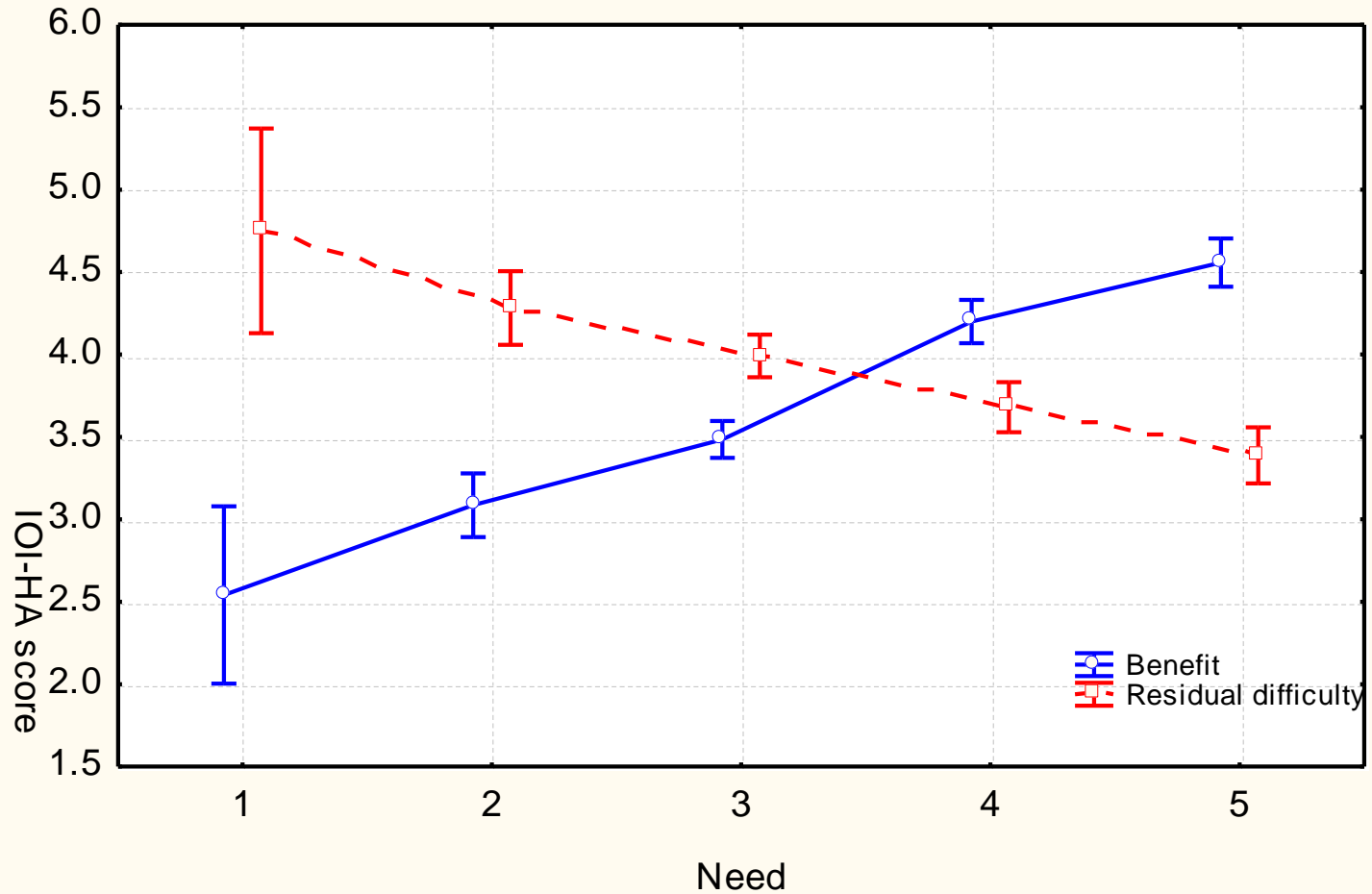

Aid ownership by hearing loss

Blue Mountains Population >55 years

Ownership

Population

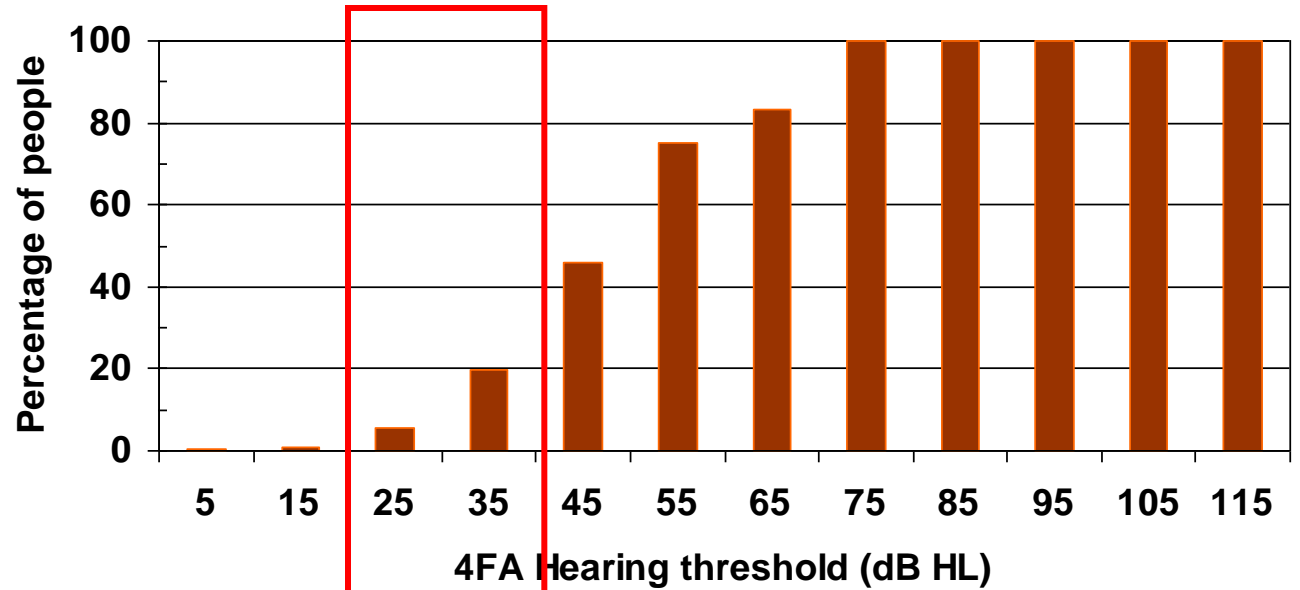

Use

Ownership

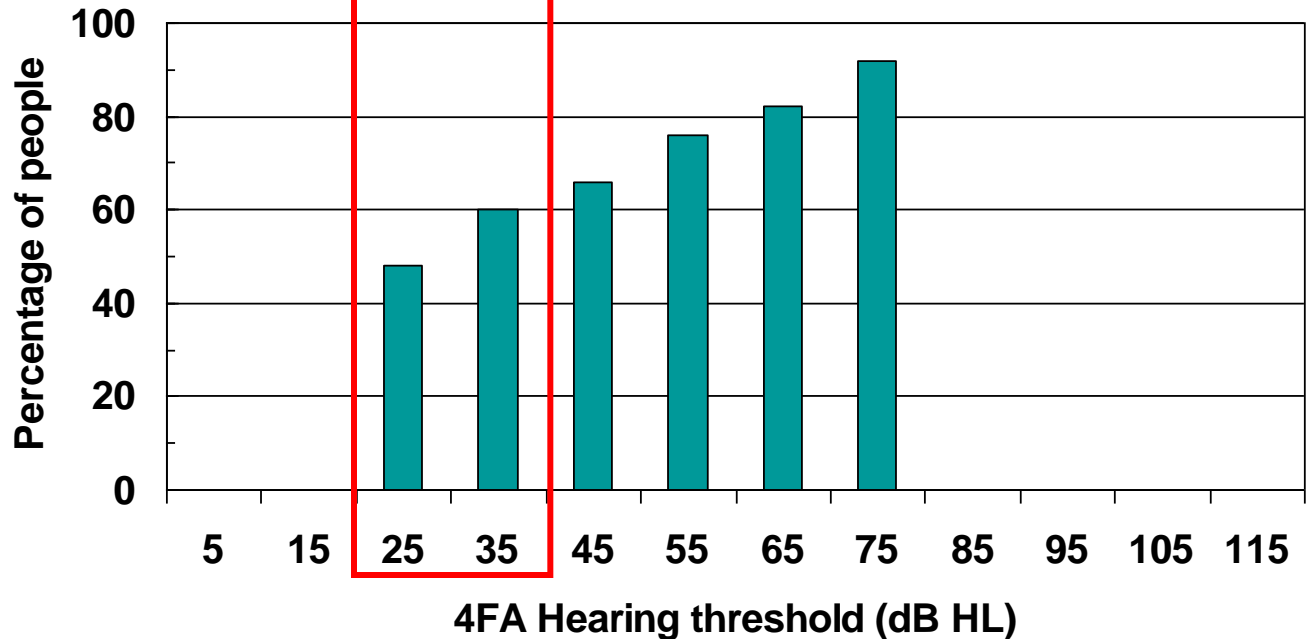

Speech intelligibility (mild loss – 22 dB 3FAHL)

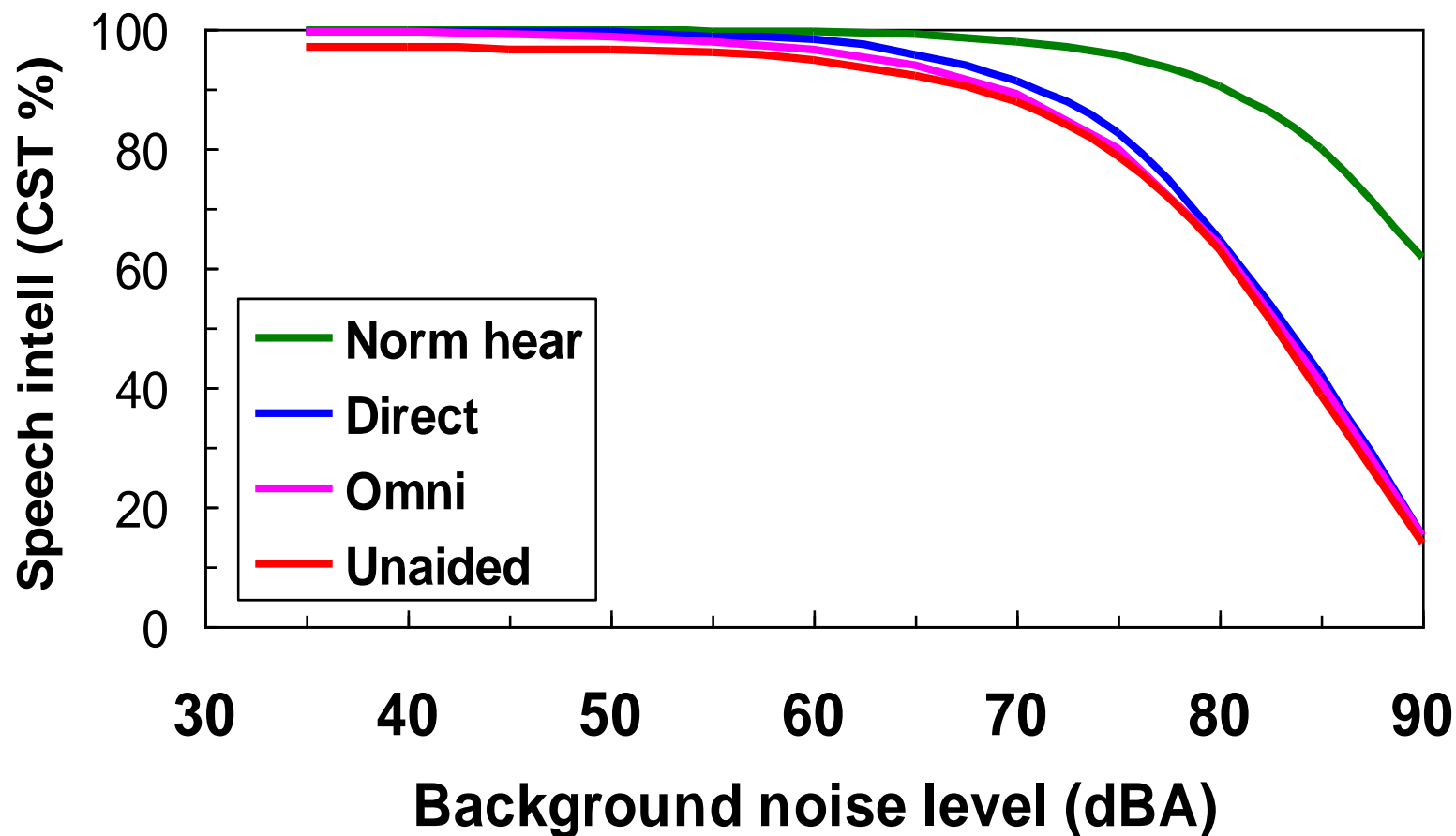

- Hearing aid “helps” in quiet places
- Tiny additional benefit from directivity

Conditions:
DI = 3 dB when REIG > 3 dB
n.h. spatial adv = 6 dB
 Δ SNR re n.h. = -3.7 dB

Speech intelligibility (moderate-severe loss – 54 dB 3FA HL)

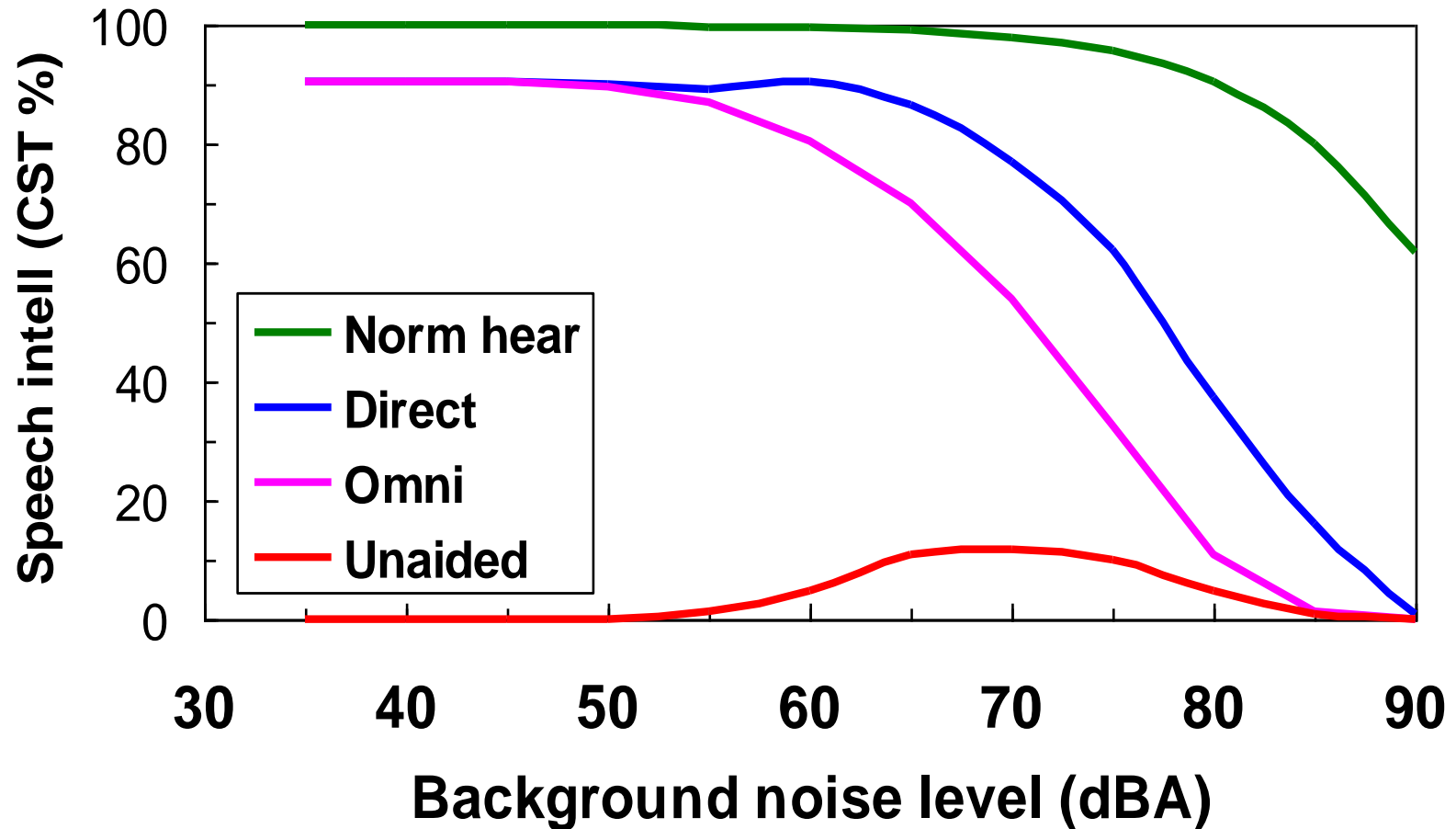

Conditions:

DI = 3 dB when REIG > 3 dB

n.h. spatial adv = 6 dB

Δ SNR re n.h. = -7.7 dB

Effects of hearing loss

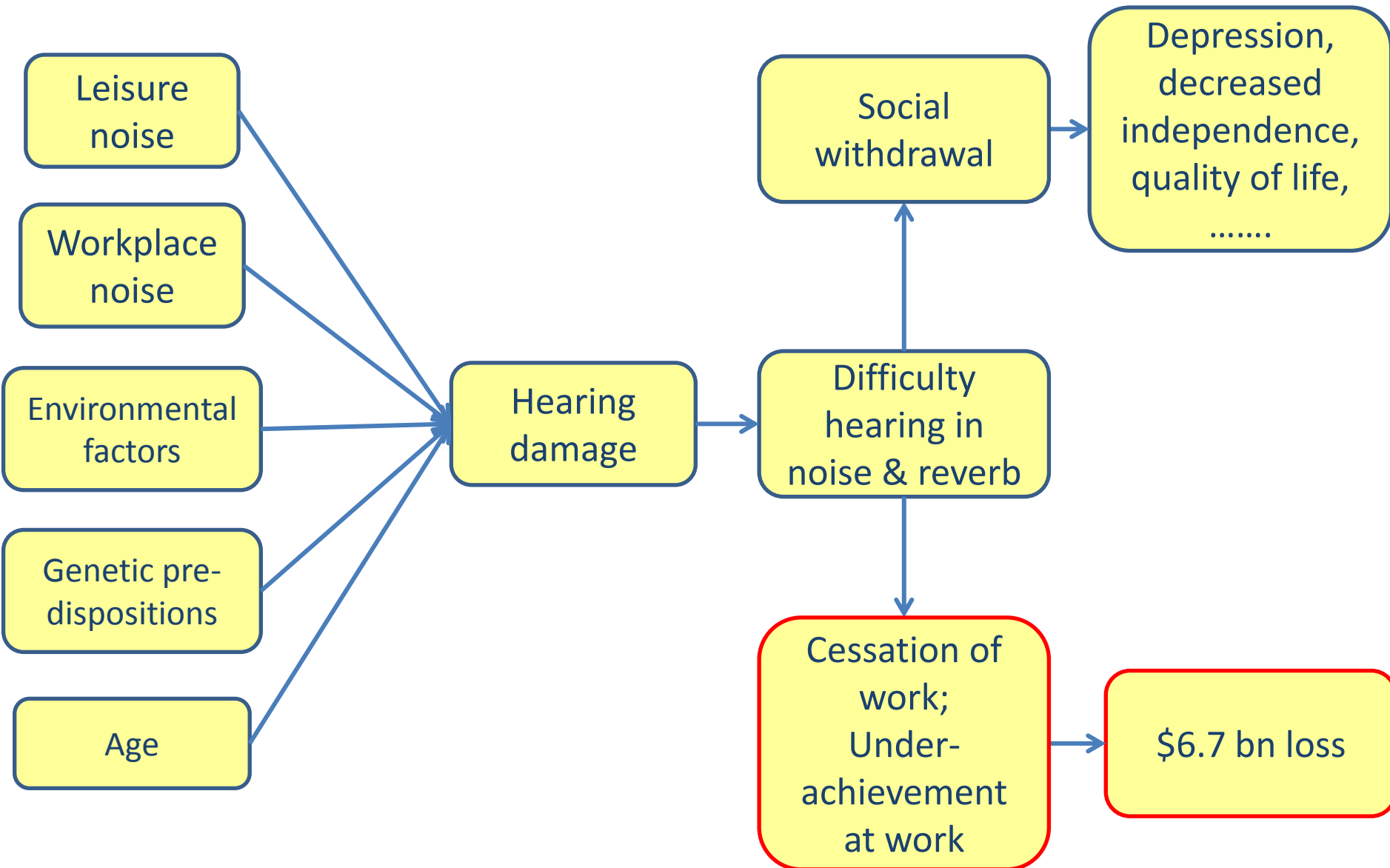

Technology of the next few
years

Super-directional hearing aids

Binaural-Processing Super-directional Microphone

(Mejia & Dillon, 2007)

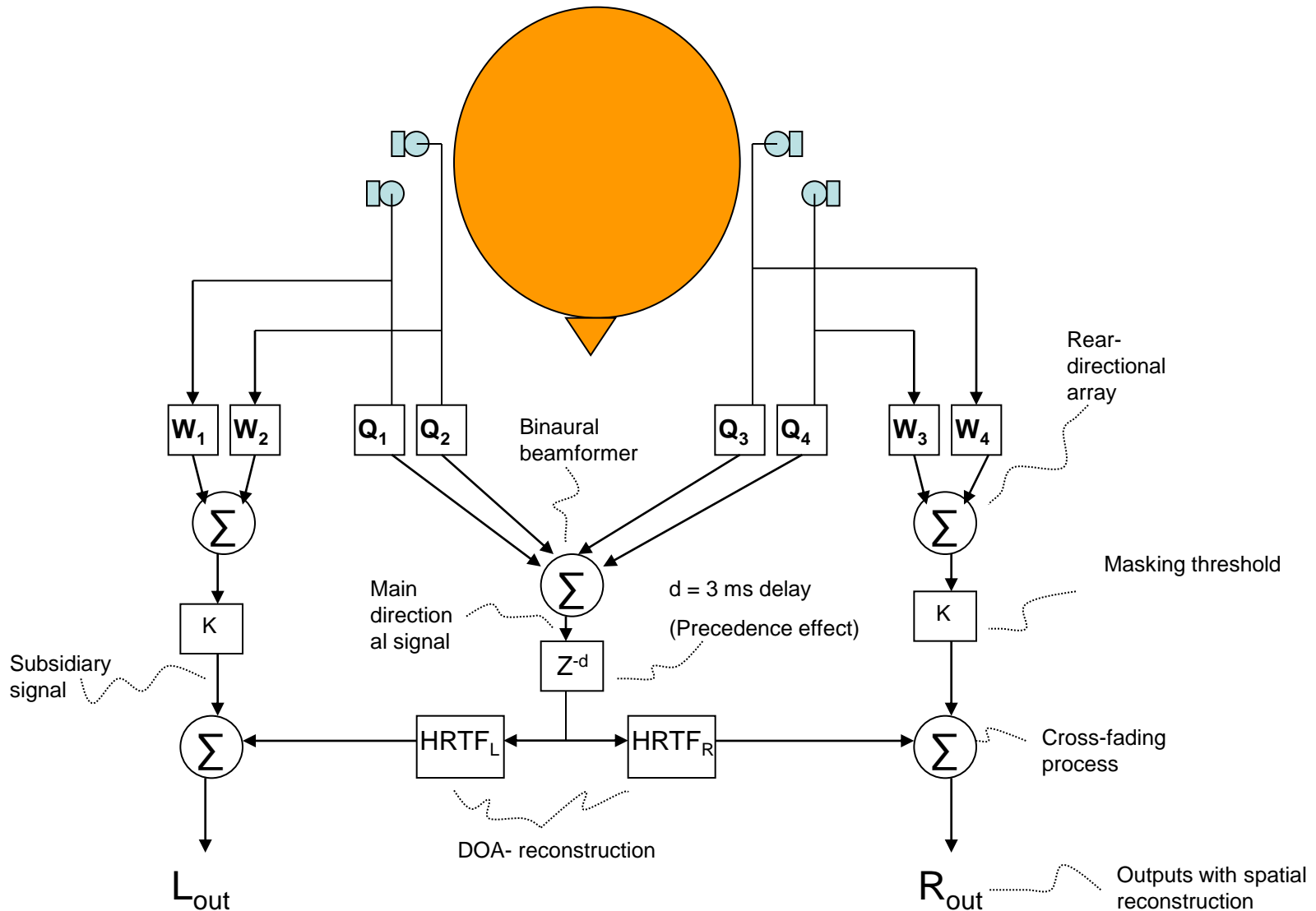

Video demo



Super-directional microphones (mild loss)

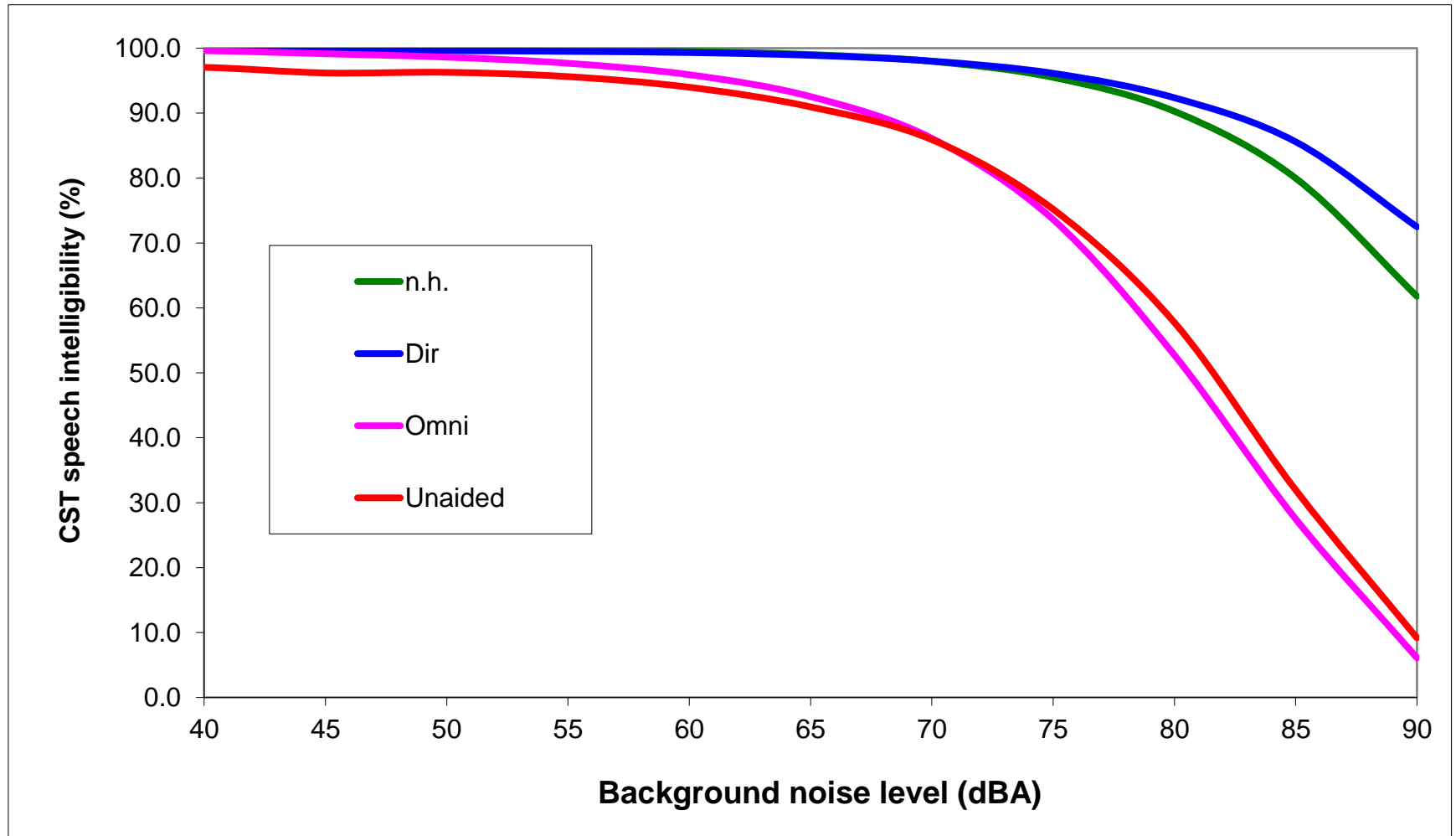

Conditions:

DI = 6 dB when REIG \geq 0 dB

n.h. spatial adv = 6 dB

Δ SNR re n.h. = -3.7 dB

Hearing aids of the future



Convergence:

- phone interface,
- computer interface,
- music player,
- GPS interface
- hearing protector,
- hearing aid/enhancer,



Thanks for your interest

In summary

- With changes in technology, usage of hearing aids within the Government's Hearing Services Program has significantly increased over the past five years.
- Hearing loss none-the-less remains more often uncorrected than corrected, particularly among people with mild and moderate hearing loss.
- Imminent further improvements in technology will likely result in hearing aids enabling some people with hearing loss to hear more clearly than people with normal hearing. This will likely smash negative perceptions and stigma that still sometimes are associated with the use of hearing aids.
- A demonstration of future super-directional hearing aid technology will be provided.